

HWLB-018

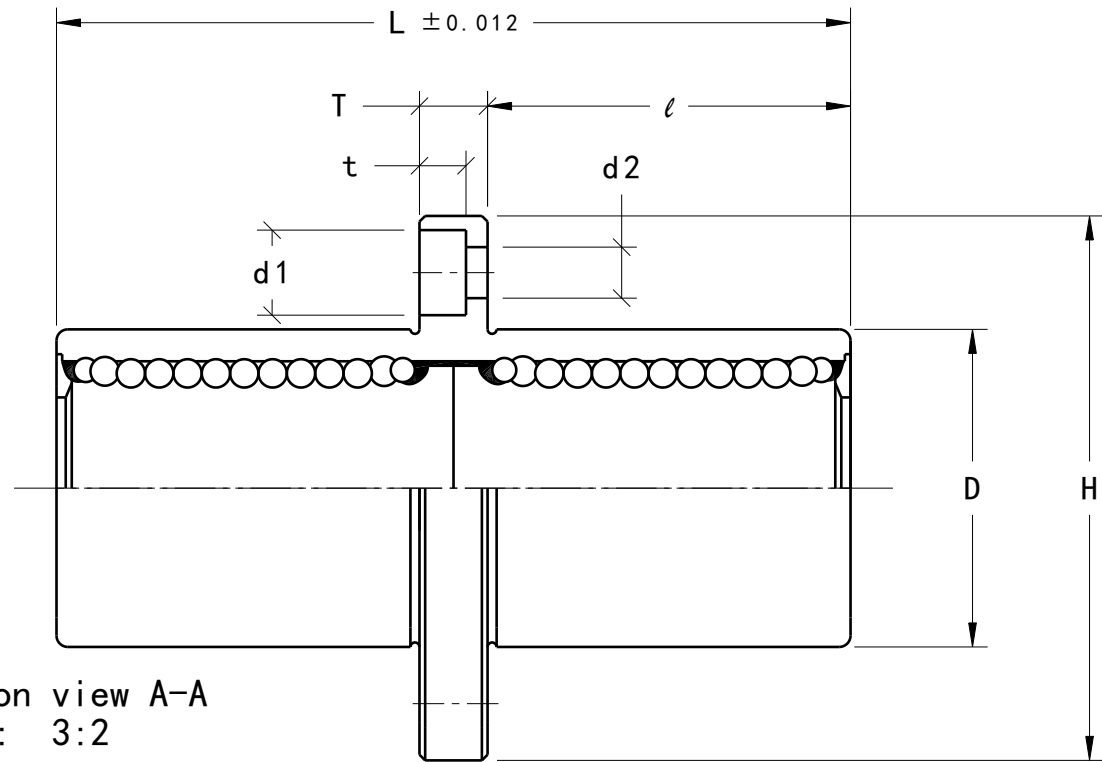

Section view A-A
Scale: 3:2

