

SFT1205~2525

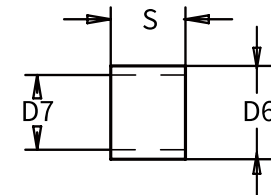
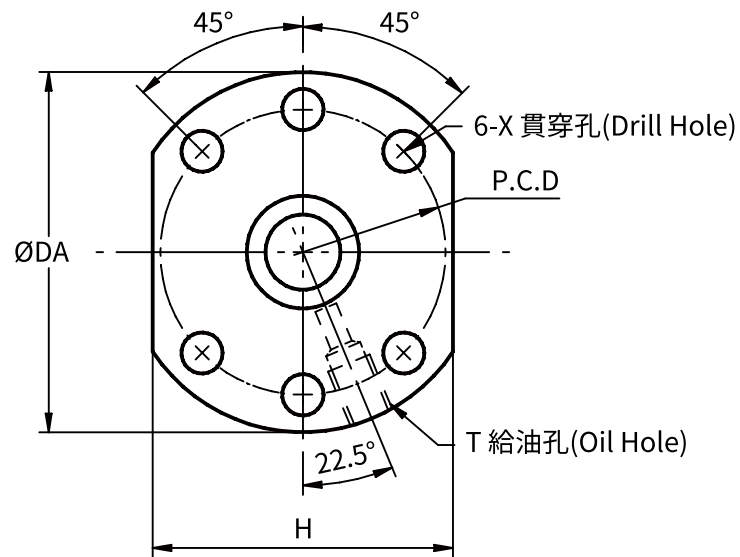

間隔套

材質：S45C

處理：四三酸化鐵皮膜

