

HFA023

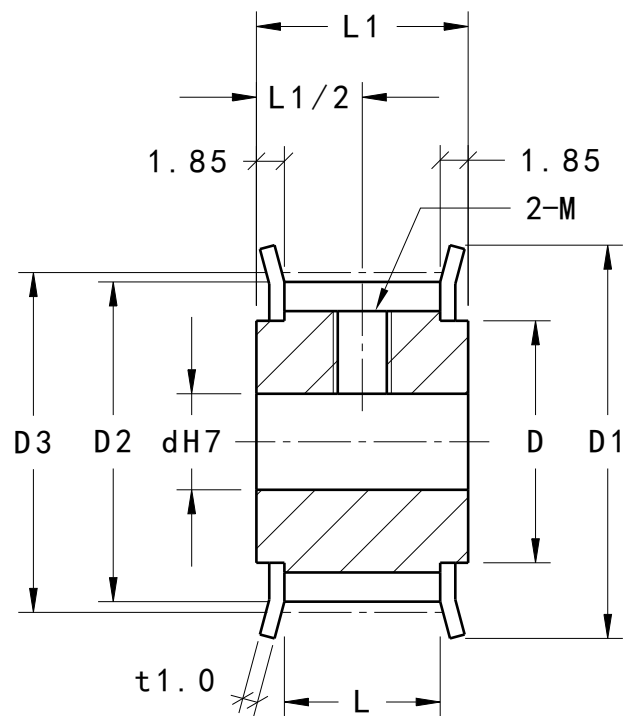

剖面視圖A-A
縮放: 2:1

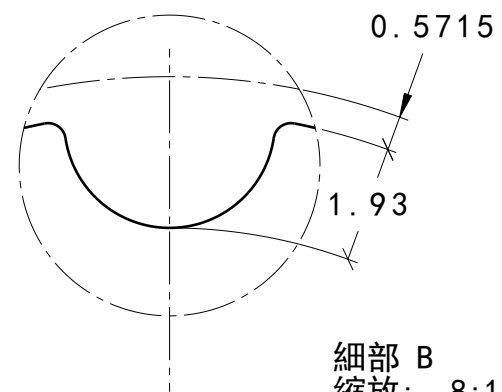

細部 B
縮放: 8:1